

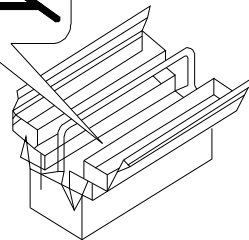

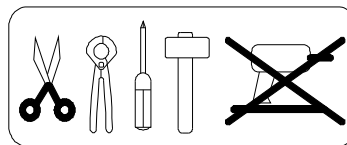

- |                                       |                                   |
|---------------------------------------|-----------------------------------|
| <b>D</b> Montageanleitung             | <b>GB</b> Assembly instructions   |
| <b>NL</b> Handleiding voor de montage | <b>PL</b> Instrukcja montazu      |
| <b>TR</b> Montaj talimati             | <b>RU</b> Инструкция по монтажу   |
| <b>FR</b> Notice de montage           | <b>IT</b> Istruzioni di montaggio |
| <b>CS</b> Montážní návod              | <b>SK</b> Návod na montáž         |
| <b>HU</b> Szerelési útmutató          | <b>RO</b> Instrucțiuni de montaj  |

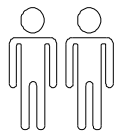
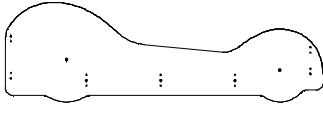
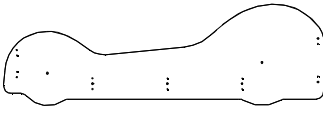
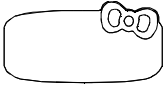
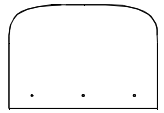
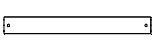
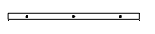

BEFORE YOU BEGIN	AVANT LE MONTAGE	MONTAGE
<p>adult assembly required</p> <p>not suitable for children under three years, due to sharp points and small parts</p> <p>Warning : choking hazard. Unassembled parts may be choking hazard to children 4 years and younger.</p> <p>Use the tools indicated on the assembly leaflet and follow the instructions.</p> <p>All assembly components must always be tightened properly. Check regularly and retighten if necessary.</p>	<p>assemblage uniquement par un adulte</p> <p>Ne convient pas aux enfants de moins de 4 ans, à cause de pièces pointues et coupantes</p> <p>Avertissement: Risque d'étouffement. Les pièces non assemblées peuvent provoquer un risque d'étouffement pour les enfants de 4 ans et moins.</p> <p>Utiliser les outils indiqués sur la notice de montage et suivre les instructions d'assemblage.</p> <p>Il convient que tous les dispositifs d'assemblage soient toujours convenablement serrés et régulièrement vérifiés, ainsi que resserrés si nécessaire.</p>	<p>Die Montage soll durch eine erwachsene Person erfolgen.</p> <p>Das Bett ist nicht geeignet für Kinder unter 4 Jahren.</p> <p>Warnung: Erstickungsgefahr. Kleinteile können eine Erstickungsgefahr bei Kinder sein.</p> <p>Verwenden Sie die angegebenen Werkzeuge zur Montage und folgen Sie der Aufbauanleitung.</p> <p>Alle Montageteile müssen fest verschraubt sein.</p> <p>Überprüfen Sie regelmässig die Festigkeit und ziehen sie wenn nötig nach.</p>
USE AND MAINTAINANCE	UTILISATION ET ENTRETIEN	VERWENDUNG UND PFLEGE
<p>Clean the surface using a slightly damp cloth and mild washing liquid if necessary.</p> <p>Do not use any cleaning product containing alcohol or ammonia. These will dull the shiny surface of the product. Furniture polish will also work to clean and dust off the surface.</p> <p><b>The following applies in general:</b> Please don't use the following detergents or cleaning agents at all :</p> <ul style="list-style-type: none"> <li>• microfibre cloths or dirt erasers they often contain fine abrasive particles which can cause scratches on the surfaces</li> <li>•aggressive chemical substances as well as abrasive cleaning agents or solvents . They may damage the surfaces too.</li> <li>•scouring powder, steel wool or scouring pads.</li> <li>•vacuum cleaners. The nozzles and brushes can cause scratches on the surfaces.</li> <li>•steam cleaners. The surfaces may be damaged or separated from the ground due to the high pressure and heat of the water vapour.</li> </ul>	<p>Nettoyer la surface à l'aide d'un chiffon légèrement humide et de liquide vaisselle doux si nécessaire.</p> <p>Ne pas utiliser de produit de nettoyage contenant de l'alcool ou de l'ammoniaque. Ces produits terniront la surface brillante du produit. Un produit de polissage des meubles peut être utilisé pour nettoyer et dépoussiérer la surface.</p> <p><b>En règle générale:</b> Veuillez n'utiliser en aucun cas les détergents suivants:</p> <ul style="list-style-type: none"> <li>• chiffons à microfibres ou gomme à saleté. Ils contiennent souvent de fine particules abrasives qui peuvent rayer les surfaces.</li> <li>•substances chimiques agressives ainsi que des détergents abrasifs. Ceux-ci peuvent également endommager les surfaces.</li> <li>•poudre à récurer, paille de fer ou éponge grattant.</li> <li>•aspirateur. les buses et les brosses peuvent rayer la surface.</li> <li>•nettoyeur à vapeur. De fait de la haute pression et de la chaleur avec lesquelles la vapeur d'eau sort sur la surface, elles peuvent être endommagées et même décoller la base.</li> </ul>	<p>Reinigen Sie die Oberfläche mit einem feuchten Tuch und bei Bedarf mit mildem Reinigungsmittel.</p> <p>Verwenden Sie keine Alkohol- oder Amoniak haltigen Reinigungsmittel. Diese schaden der Oberfläche.</p> <p>Zur Pflege verwenden Sie bitte keine Mikrofasertücher oder Schmutz Radiergummis. Diese enthalten Schleifmittel, die die Oberfläche beschädigen.</p> <p>Keine aggressiven chemischen Mittel wie Scheuermilch oder Andere Lösungsmittel. Keine Scheuerpulver, Stahlwolle, Scheuerschwämme.</p> <p>Staubsauger Düsen und Bürsten können Kratzer verursachen.</p> <p>Keine Dampfreiniger verwenden. Durch den hohen Druck oder der Wärme des Wasserdampfes kann die Oberfläche beschädigt werden.</p>

# SCLB200

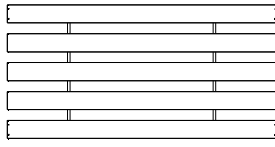
ITEM NO.	MEASUREMENT	QTY	SHAPE	CARTON NO.
①	2130 X 600 X 15	X1		1-4
②	2130 X 600 X 15	x1		1-4
③	930 X 446 X 15	x1		2-4
④	930 X 600 X 15	x1		2-4
⑤	930 X 98 X 15	x3		2-4
⑥	900 x 40 x 15	x2		2-4
⑦	70 x 70 x 15	x4		3-4
⑧	400 X 400 X 15	x2		3-4
⑨	312 X 312 X 15	x2		3-4
⑩	2007 X 930 X 12	x1		4-4

2010x930

SCLB200 20F7

Ver1.013

00  
10  
20  
30  
40  
50  
60  
70  
80  
90  
100  
110  
120  
130  
140  
150  
160  
170  
180  
190  
200

Service • Asistenza • Dienstverlening • Serwis  
Servis • Szerviz • Сервисная служба



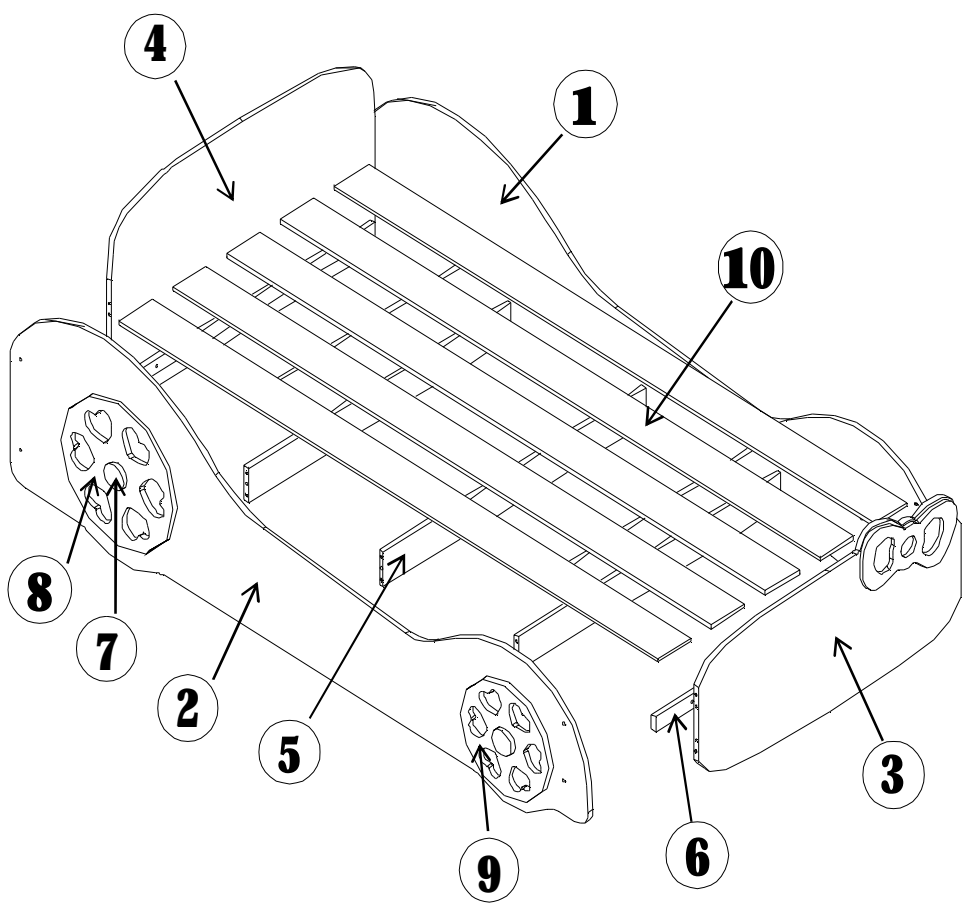

Name • Nom • Nome • Naam • Nazwa • Jméno • Názov • Név • Denumire • Isim • Название	
Nr. • No. • N° • Номер • Číslo • Sz	
Typ • Type • Тір • Tipus • Тіро • Тип	

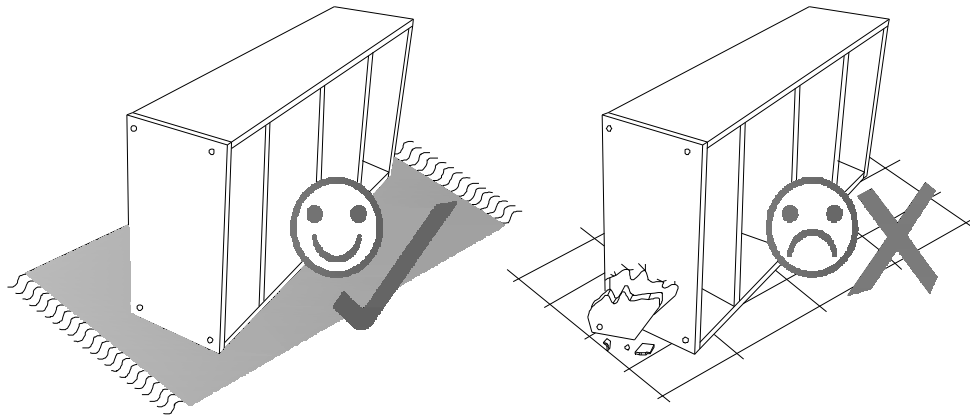

- |                             |                              |                             |                            |                            |                            |
|-----------------------------|------------------------------|-----------------------------|----------------------------|----------------------------|----------------------------|
| <b>A</b><br><br>x6          | <b>B</b><br><br>x6           | <b>C</b><br>8x30<br><br>x20 | <b>D</b><br>6x25<br><br>x6 | <b>E</b><br>6x35<br><br>x4 | <b>F</b><br>6x50<br><br>x8 |
| <b>G</b><br>10x11<br><br>x8 | <b>H</b><br>3.5x29<br><br>x8 | <b>I</b><br><br>x4          |                            |                            |                            |



**1**

<b>B</b>	<b>C</b>	<b>G</b>	<b>I</b>
 x6	 8x30 x20	 10x11 x8	 x4

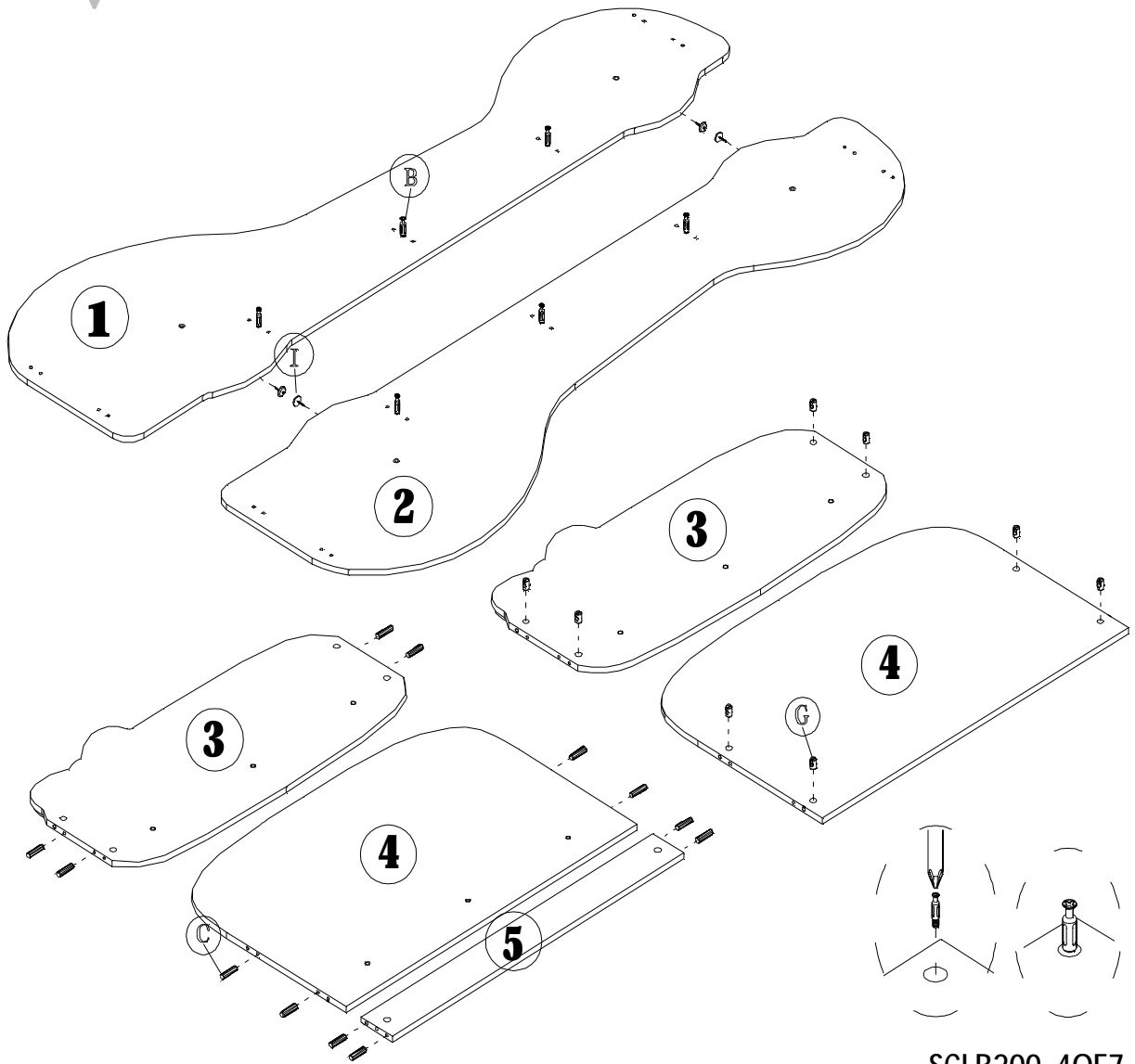

SCLB200 4OF7  
Ver1.013

**2**

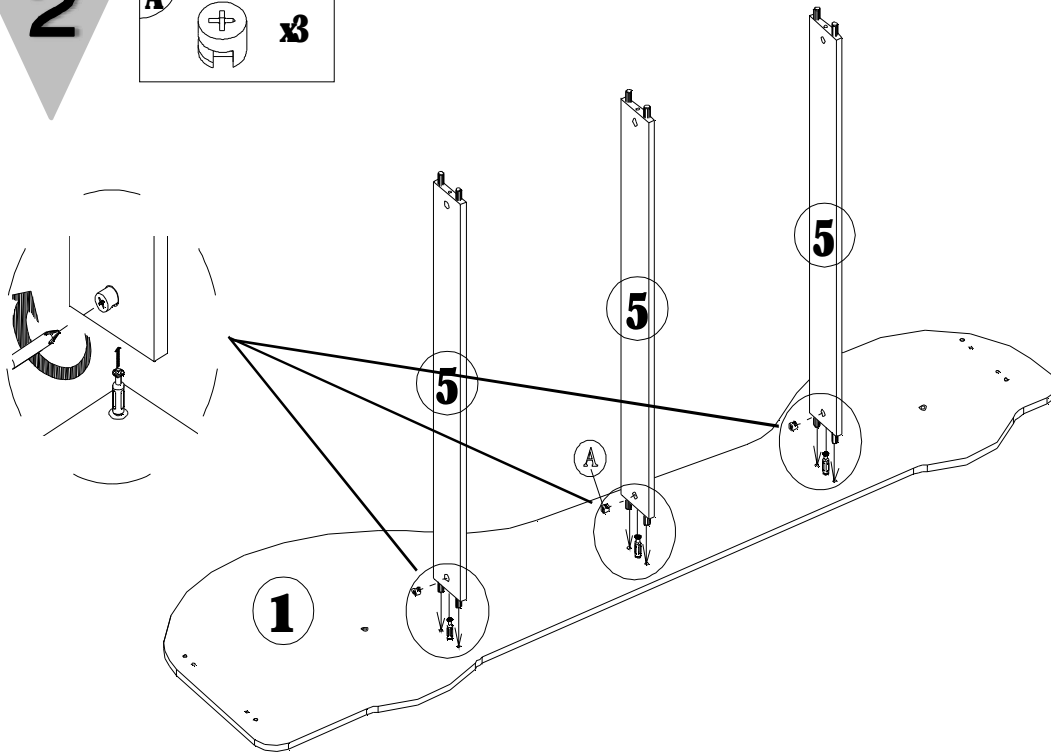
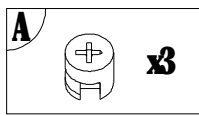

**3**

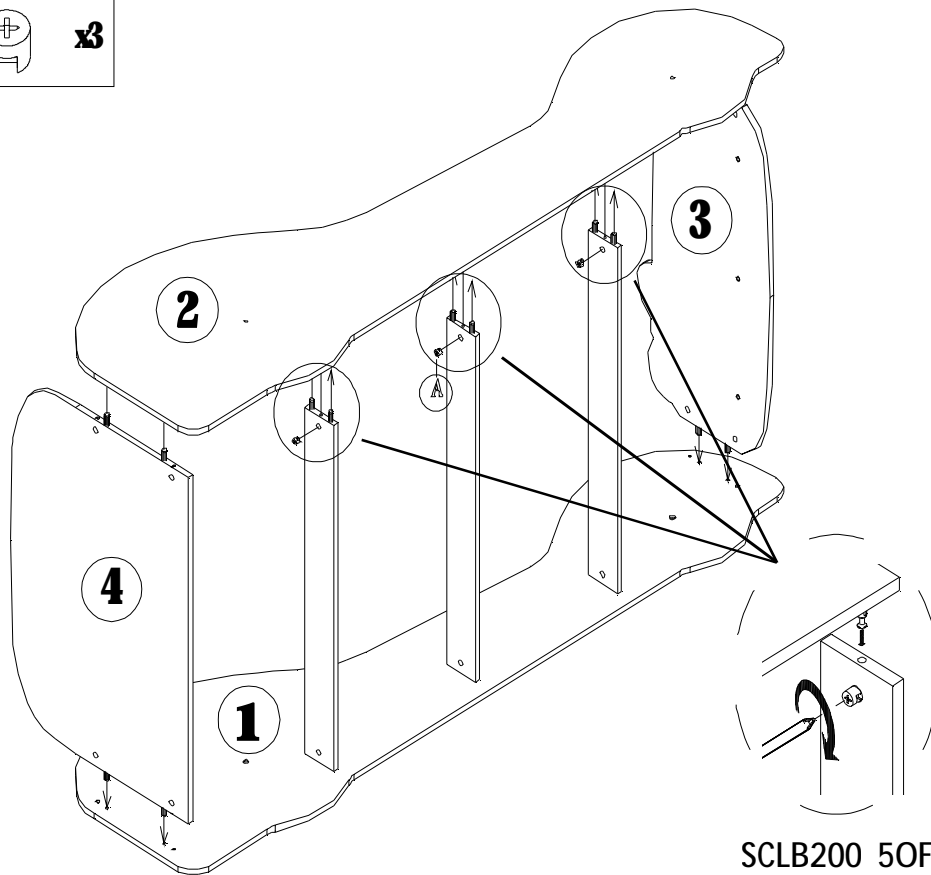
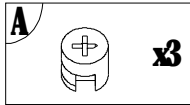

SCLB200 50F7  
Ver1.013

**4**

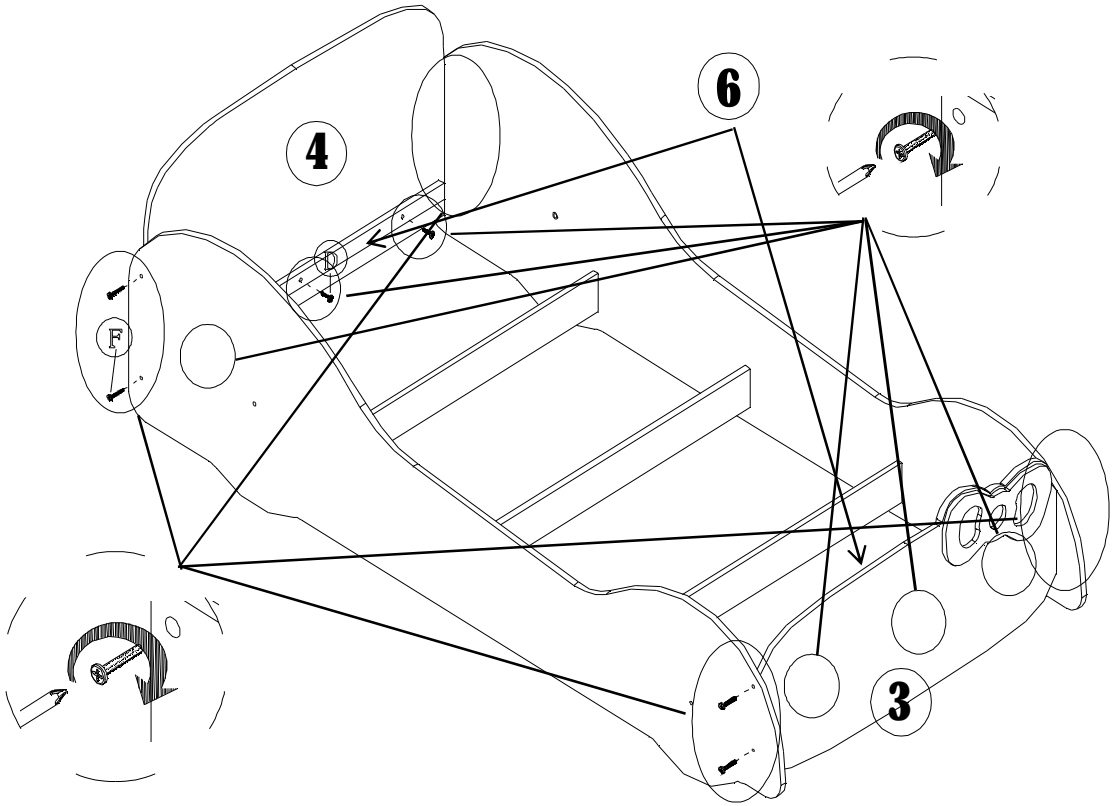
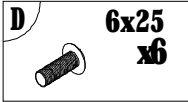

**5**

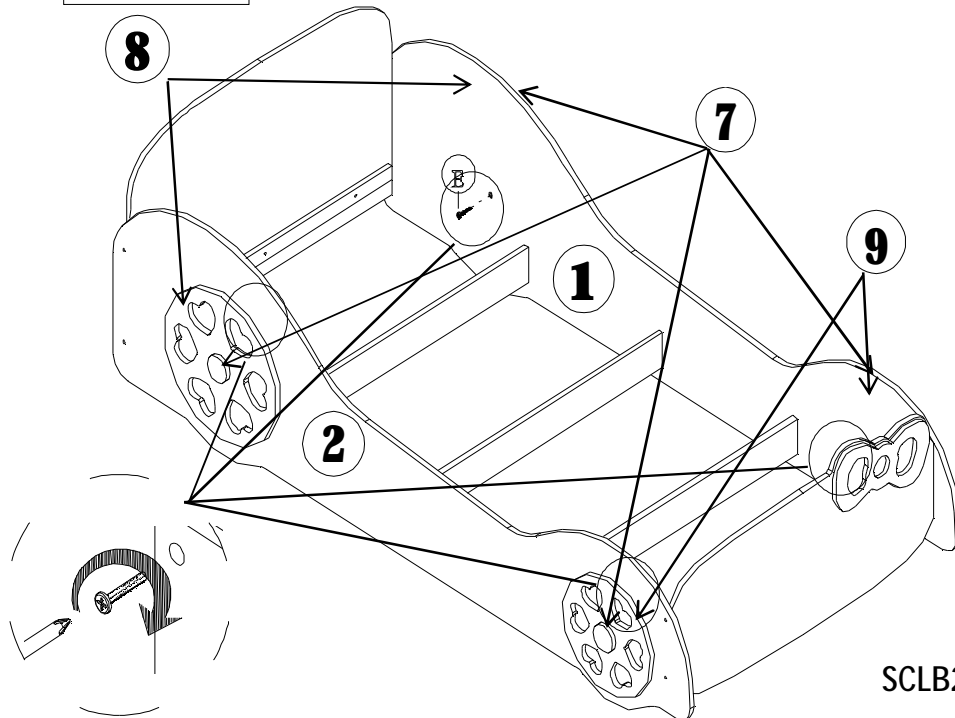

6

H 3.5x29  
x8

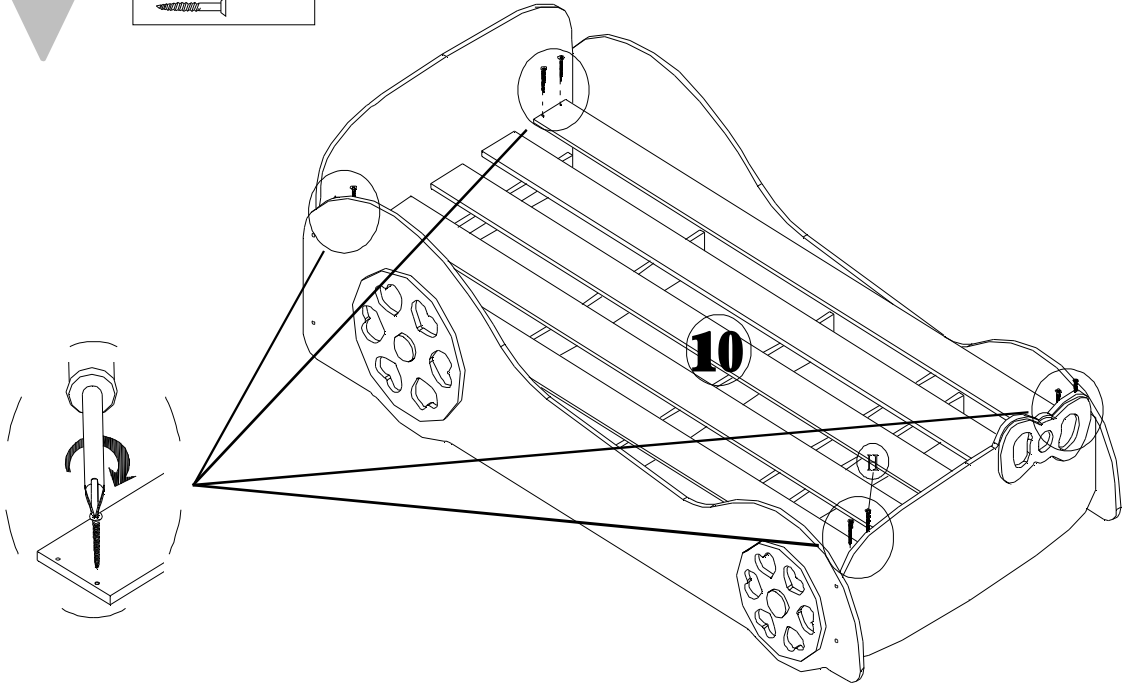

7

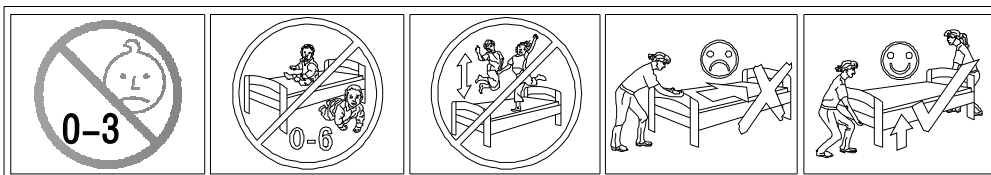
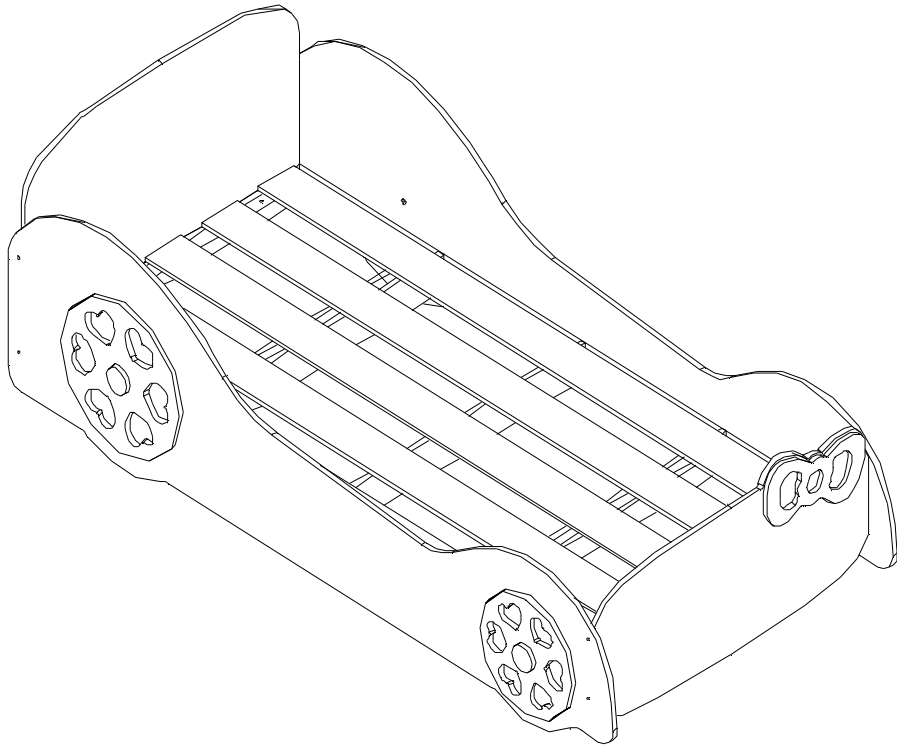

SCLB200 7OF7  
Ver1.013